

The reproduction, distribution and utilization of this document as well as the communication of its contents to others without explicit authorization is prohibited. Offenders will be held liable for the payment of damages. All rights reserved in the event of the grant of a patent, utility model or design.

Weitergabe sowie Vervielfältigung dieses Dokuments, Verwertung und Mitteilung seines Inhalts sind verboten, soweit nicht ausdrücklich gestattet. Zuwiderhandlungen verpflichten zu Schadenersatz. Alle Rechte für den Fall der Patent-, Gebrauchsmuster- oder Geschmacksmusterertragung vorbehalten.

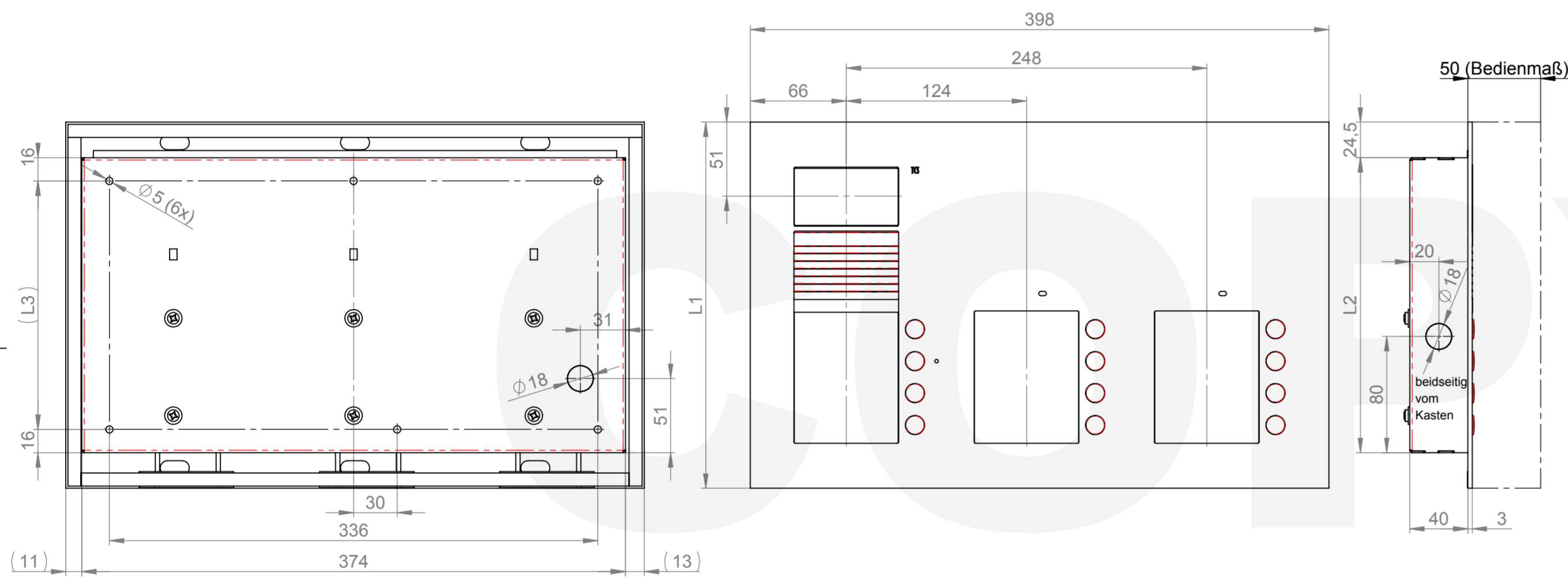
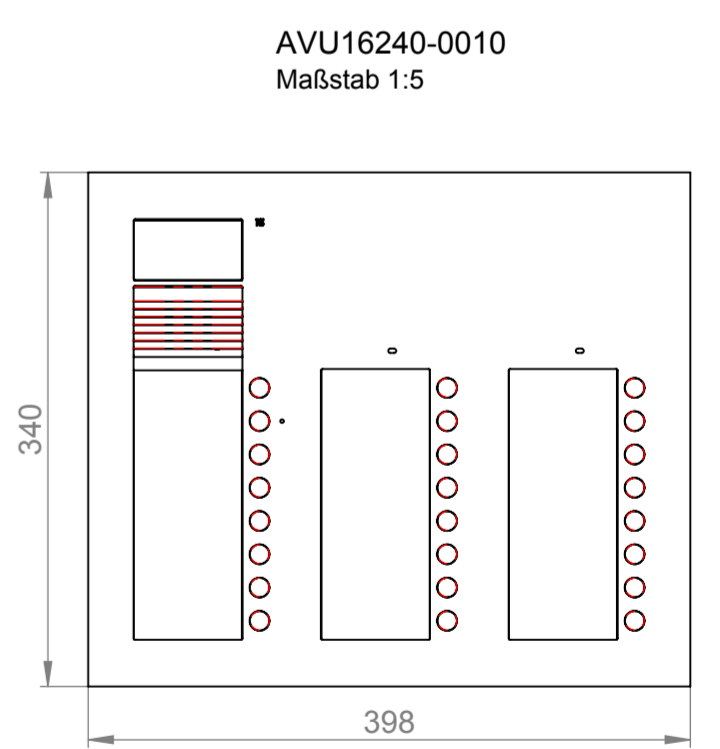
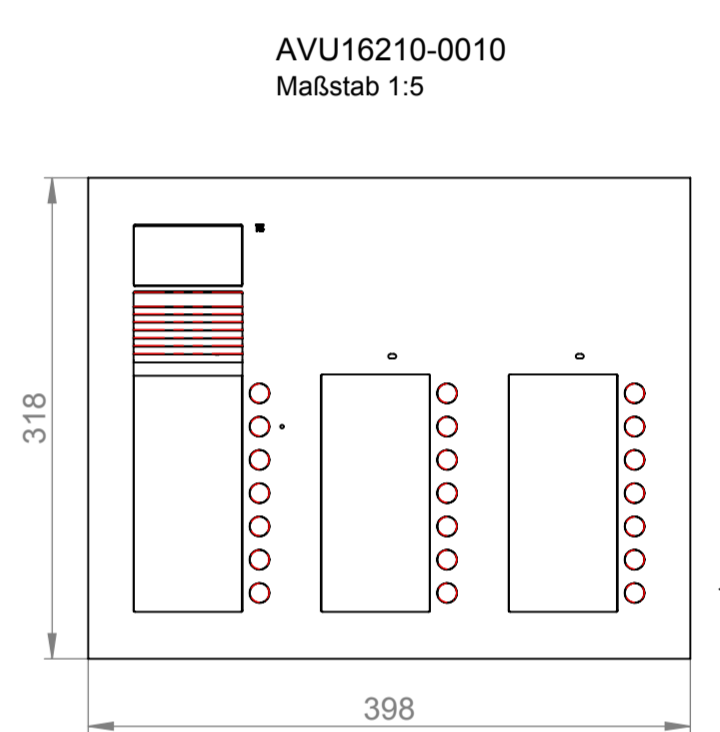
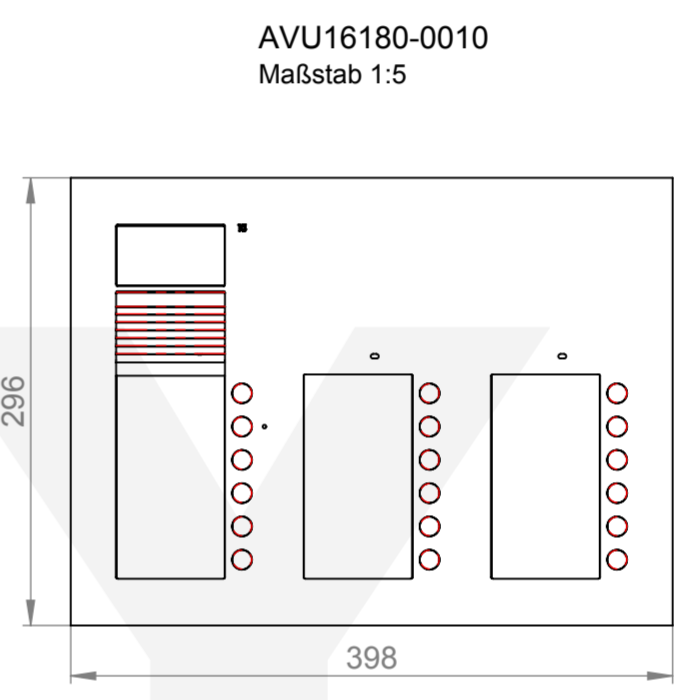
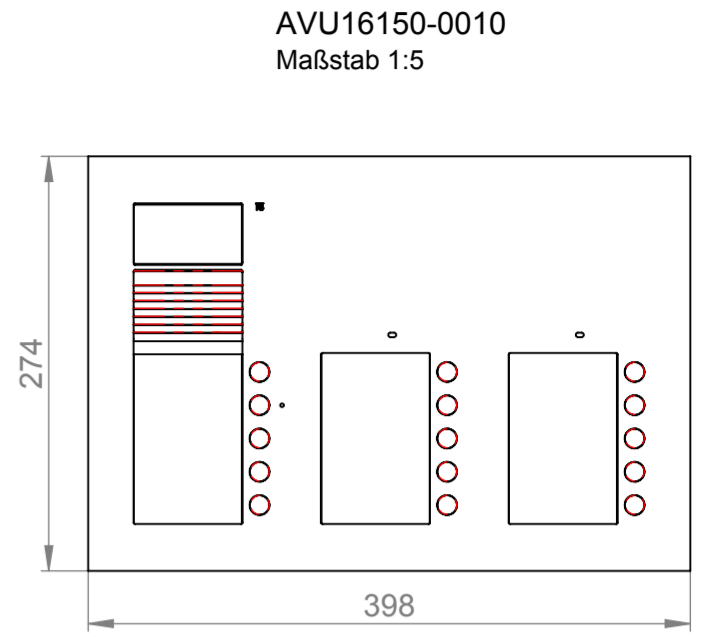
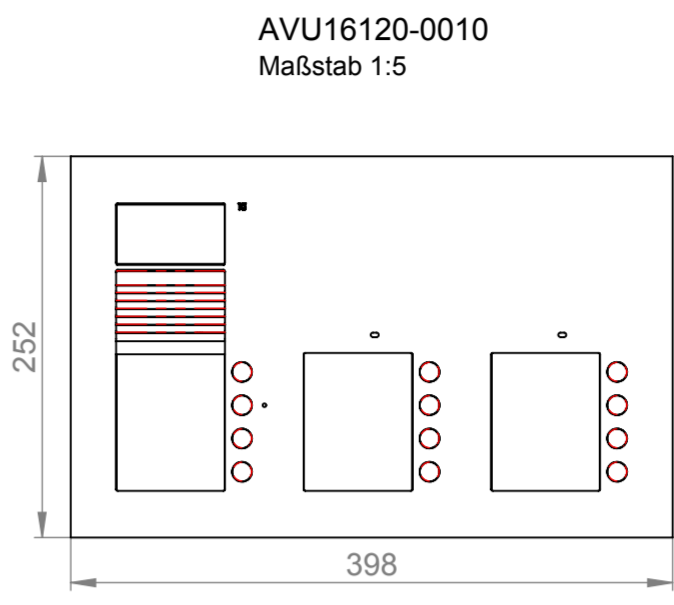
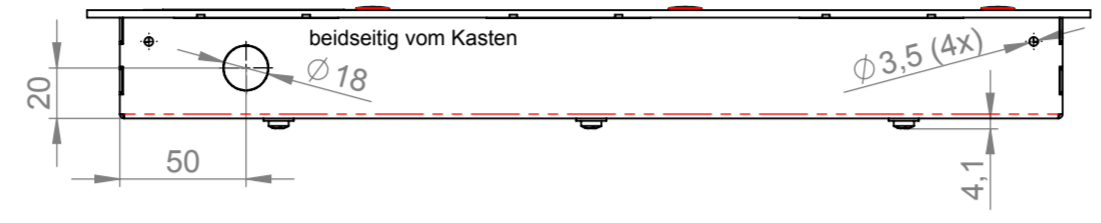

Anzahl Tasten	12	15	18	21	24
Material: eloxiert natur	AVU16120-0010	AVU16150-0010	AVU16180-0010	AVU16210-0010	AVU16240-0010
L1	252	274	296	318	340
L2	203	225	247	269	291
L3	171	193	215	237	259

Hohlwandmontage über ZAU4001-0002 nachrüstbar

allg. Toleranzen nach: DIN ISO 2768-1 m DIN ISO 2768-2 K		Freigabe: 		Maßstab: 1:3 Halbzeug:	Gewicht: 2163.84 gr. Werkstoff:
		Datum 01.07.2016		Serie AVU 3-spaltig AVU16xx0-xxxx Vertriebszeichnung	
		Name THRE			
		Gepr. 01.07.2016			
		TCS TürControlSysteme AG www.tcsag.de			
03	1055	17.06.2016	THRE	004-502-03-01 EDV Nr.: 004-03-00-XX-00_Zusammenbau_VPUK_Jalousie A2	
02	335	18.09.2007	Fe		
01	224	29.06.2006	Fe		
Zust.	Änderung	Datum	Name		

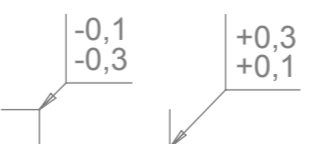

The reproduction, distribution and utilization of this document as well as the communication of its contents to others without explicit authorization is prohibited. Offenders will be held liable for the payment of damages. All rights reserved in the event of the grant of a patent, utility model or design.

Weitergabe sowie Vervielfältigung dieses Dokuments, Verwertung und Mitteilung seines Inhalts sind verboten, soweit nicht ausdrücklich gestattet. Zuwiderhandlungen verpflichten zu Schadenersatz. Alle Rechte für den Fall der Patent-, Gebrauchsmuster- oder Geschmacksmusterertragung vorbehalten.

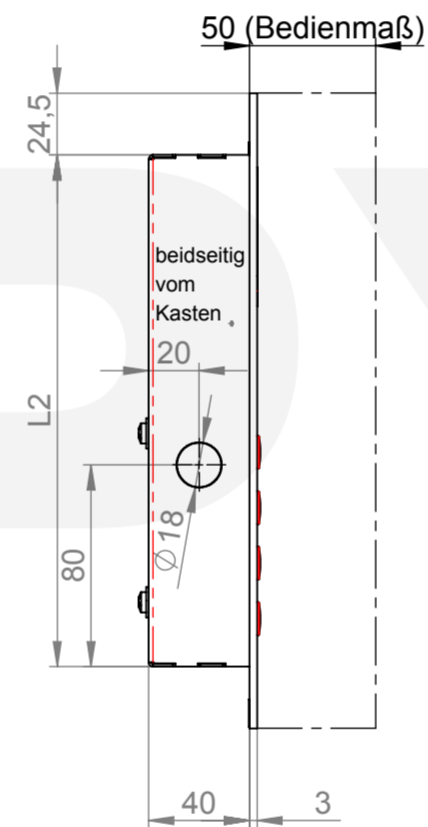
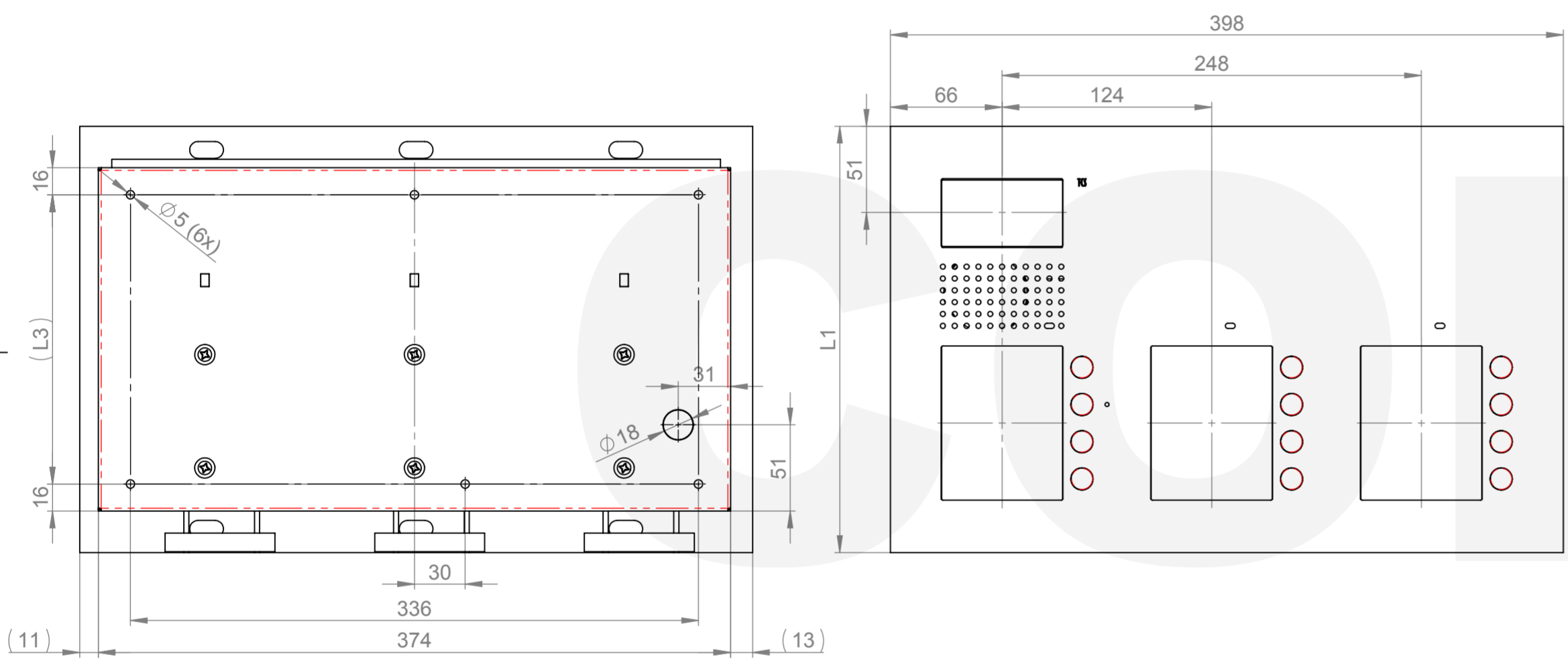
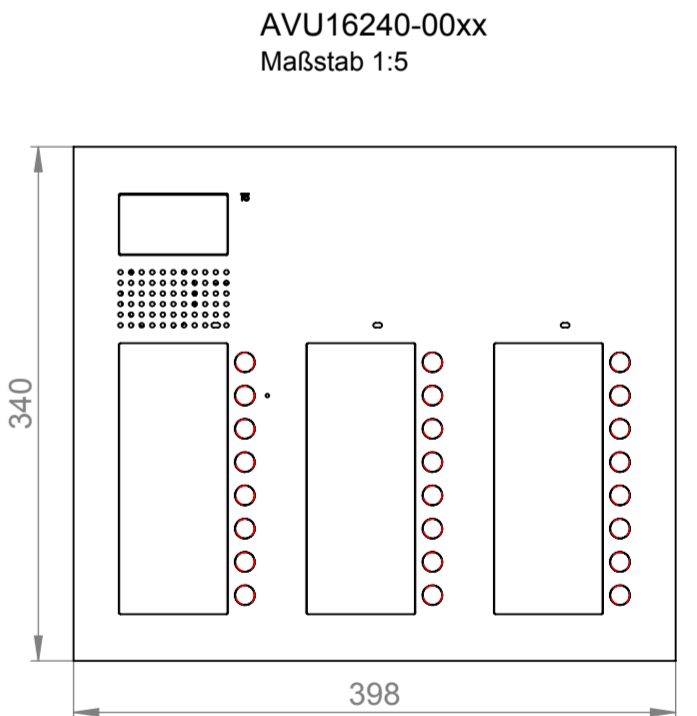
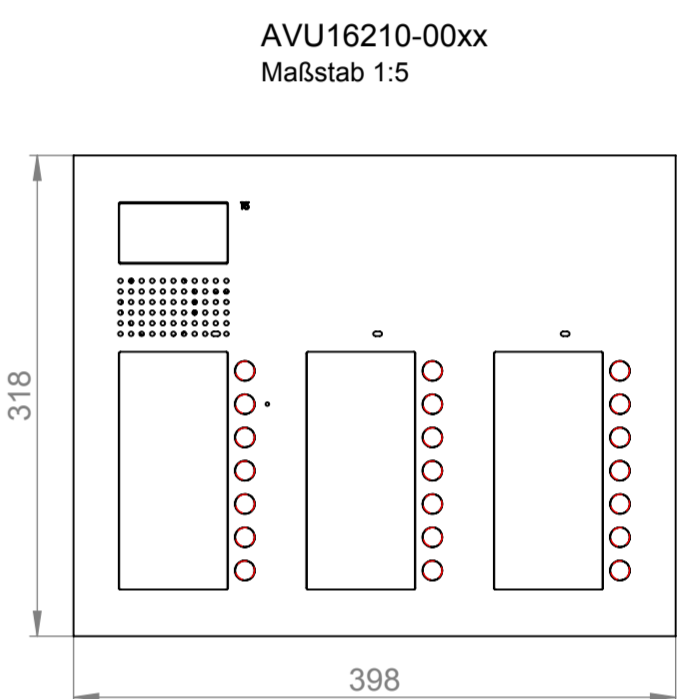
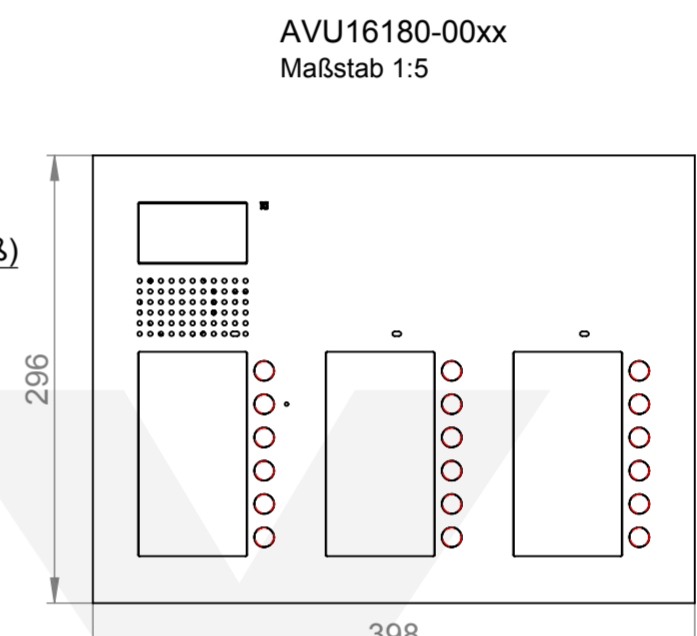
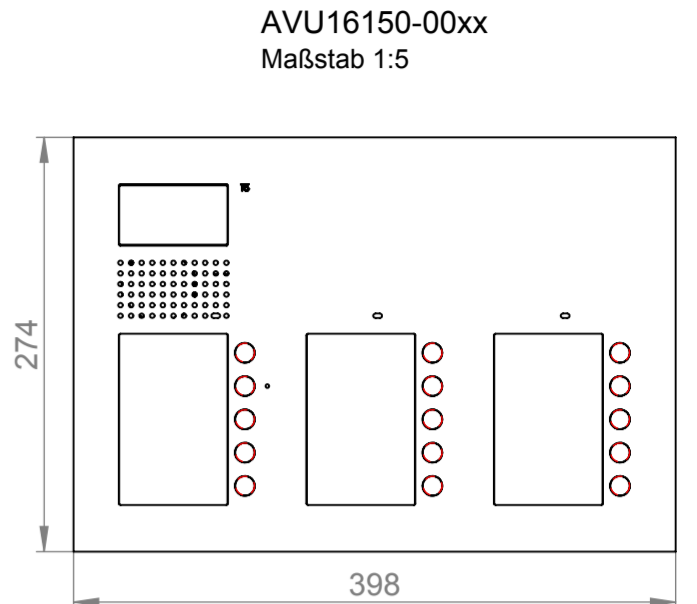
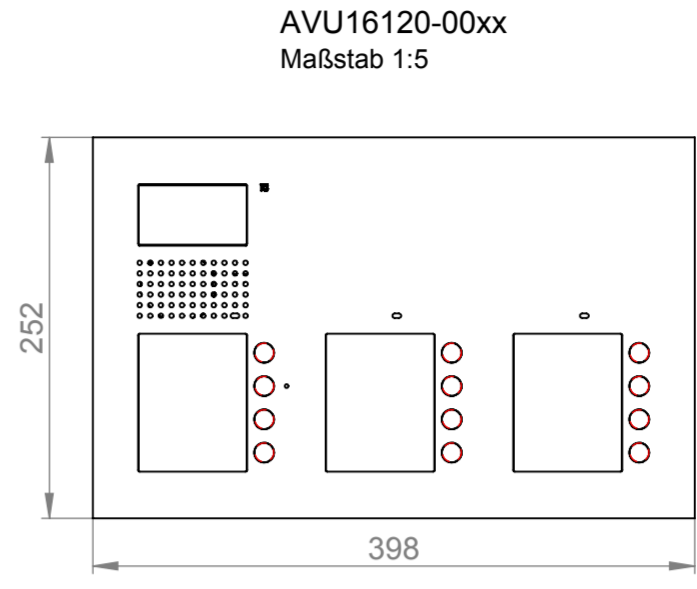
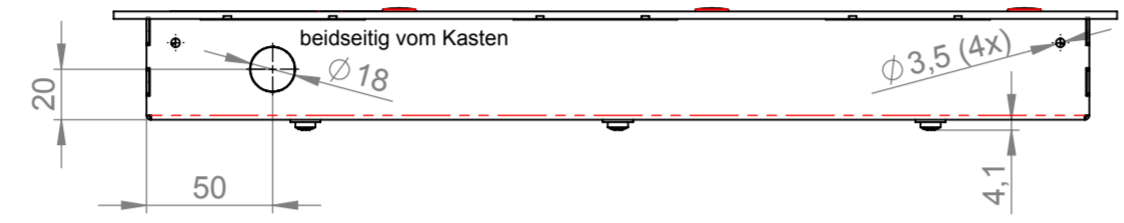

Anzahl Tasten	12	15	18	21	24
Material: eloxiert bronze	AVU16120-0012	AVU16150-0012	AVU16180-0012	AVU16210-0012	AVU16240-0012
Material: weiss beschichtet	AVU16120-0019	AVU16150-0019	AVU16180-0019	AVU16210-0019	AVU16240-0019
Material: Edelstahl geschliffen	AVU16120-0030	AVU16150-0030	AVU16180-0030	AVU16210-0030	AVU16240-0030
L1	252	274	296	318	340
L2	203	225	247	269	291
L3	171	193	215	237	259

Hohlwandmontage über ZAU4001-0002 nachrüstbar

allg. Toleranzen nach: DIN ISO 2768-1 m DIN ISO 2768-2 K		Freigabe: 		Maßstab: 1:3	Gewicht: 2183.90 gr.
				Halbzeug:	Werkstoff:
		Datum Name		Serie AVU 3-spaltig AVU16xx0-xxxx Vertriebszeichnung	
		Bearb. 01.07.2016 THRE			
		Gepr. 01.07.2016 THE			
		TCS TürControlSysteme AG www.tcsag.de			
03	1055	17.06.2016	THRE	004-502-03-01	
02	335	18.09.2007	Fe		
01	224	29.06.2006	Fe		
Zust.	Änderung	Datum	Name	EDV Nr.: 004-02-00-XX-00_Zusammenbau_VPUK	
				Blatt	1
				2 Bl.	A2

